

# User Manual

## UHF RFID Standalone Terminal

---

Version: 1.0

Date: December, 2017

# Connet

1. Product Summarize.....	1
2. UHF RFID Standalone Terminal .....	1
3. Parameters Specifications.....	2
4. Safety Precautions .....	3
5. Modifying Setting via Demo.....	3
6. Access to Software.....	5
6.1. Access to ZKAccess .....	5
6.2. Access to ZKBioSecurity .....	8
7. Solution.....	8
8. Note .....	10

# 1. Product Summarize

U1000E, U1000F, U2000E, U2000F is a new generation of RFID UHF series products for our company's independent research and development of the long distance RFID Standalone Terminal in the parking lot and access control system.

The product uses the industry's most cost-effective UHF card reader chip, and the part of swing card adopts the module integrated design, making the product to meet the technical requirements of the parking lot and access control system. Meanwhile, the utility model has the advantages of stable reading performance, good consistency, low working current and temperature, long service life, and small external influence, and the product adopts the waterproof outer shell design.

The product is also a fully meet the CE, FCC technology requirements of the product, and to obtain CE, FCC and other security certification.

# 2. UHF RFID Standalone Terminal

## ● Overview:



Dimension  
250mm\*250mm\*70mm (U1000E, U1000F)  
445mm\*445mm\*70mm (U2000E, U2000F)

## ● Lateral View and Interface:

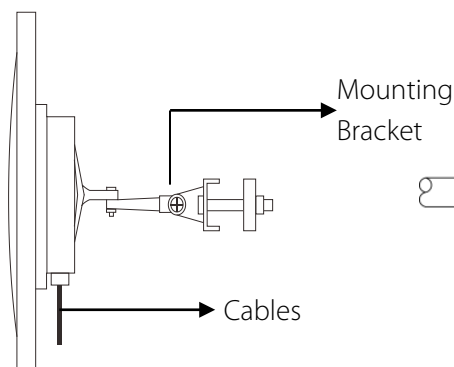

## Cables

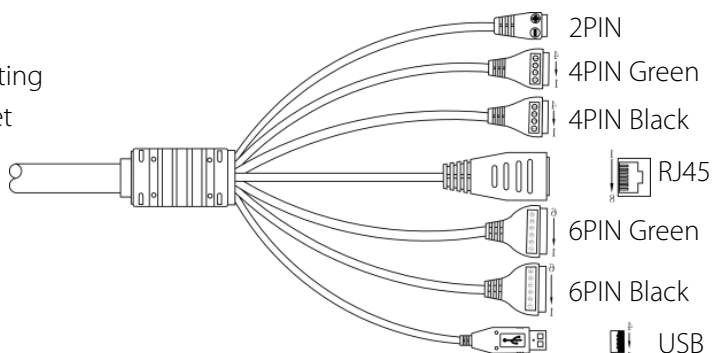

### Cable Definition:

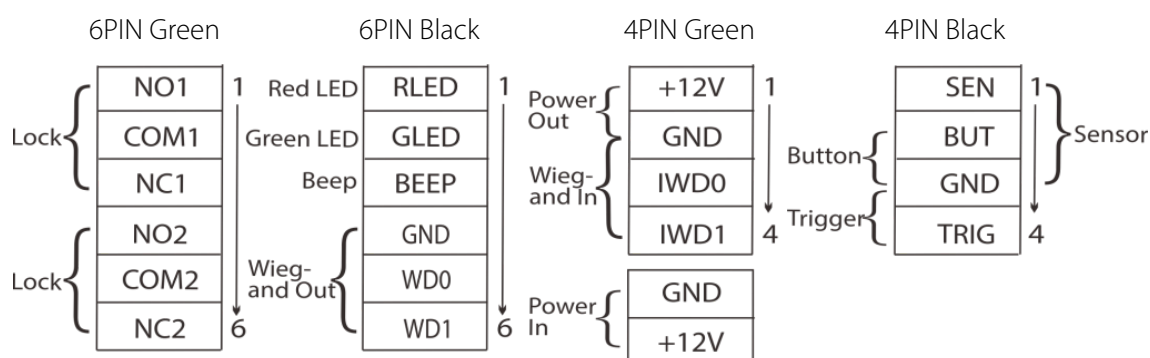

## 3. Parameters Specifications

Model	U1000E , U1000F	U2000E , U2000F
Logo&Color	ZKTeco logo, black (standard)/White logo, white(optional)	
Card Capacity	5000 cards	
Log Capacity	30,000 Transactions	
Reading Distance	0-6m(Stable is 0-5meters)	0-12m(Stable is 0-10meters)
Communication	TCP/IP ,USB,Wiegand26/34	
Access Control Interface	3rd Party Electric Lock, Door Sensor, Exit Button, Alarm	
Wiegand Signal	Wiegand input & output	
Working Frequency	F:902Mhz-926MHz; E:865MHz-868MHz	
Support Card	Tag1,Tag2,Tag3,Tag4,DF01Card,DF02 Card	
UHF Interface Protocol	EPC global UHFClass1Gen2/ISO18000-6c	
Antenna Gain	8dBi	12dBi
Output Power	18dBm-26dBm	
Maximum power consumption	<2W(RF output 26dBm,single tags)	
Ingress Protection Rate	IP 66	
Supporting Software	ZKAccess3.5;ZKBiosecurity3.0	
Working Voltage	DC 9V-12V	
Working Current	150mA (always reading )	
Working Temperature	-20°C-+60°C	
Working Humidity	<95% (25°C)	
Dimension	250mm*250mm*70mm(±5)	445mm*445mm*70mm(±5)

## 4. Safety Precautions

- 1) The Standalone Terminal working voltage ranges from DC9V to DC16V, it is recommended to use DC12V /3A power supply.
- 2) Please wire according to the cable definition.

## 5. Modifying Setting via Demo

- 1) USB Connection

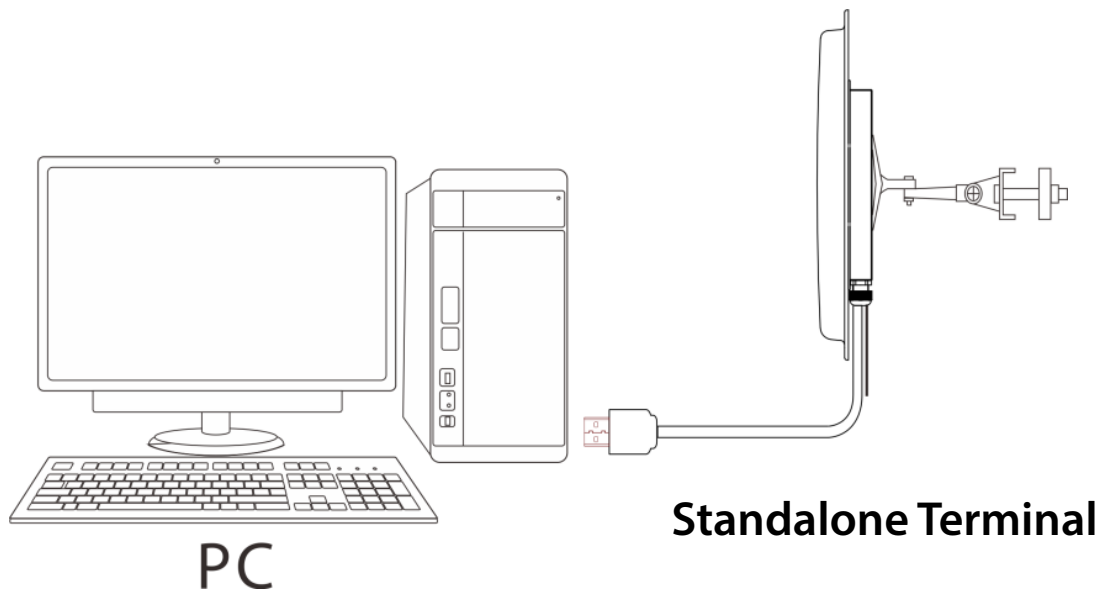

- 2) Software Introduction

Our company provides Demo, used to set the working parameters of the Standalone Terminal. Demo interface as shown below:

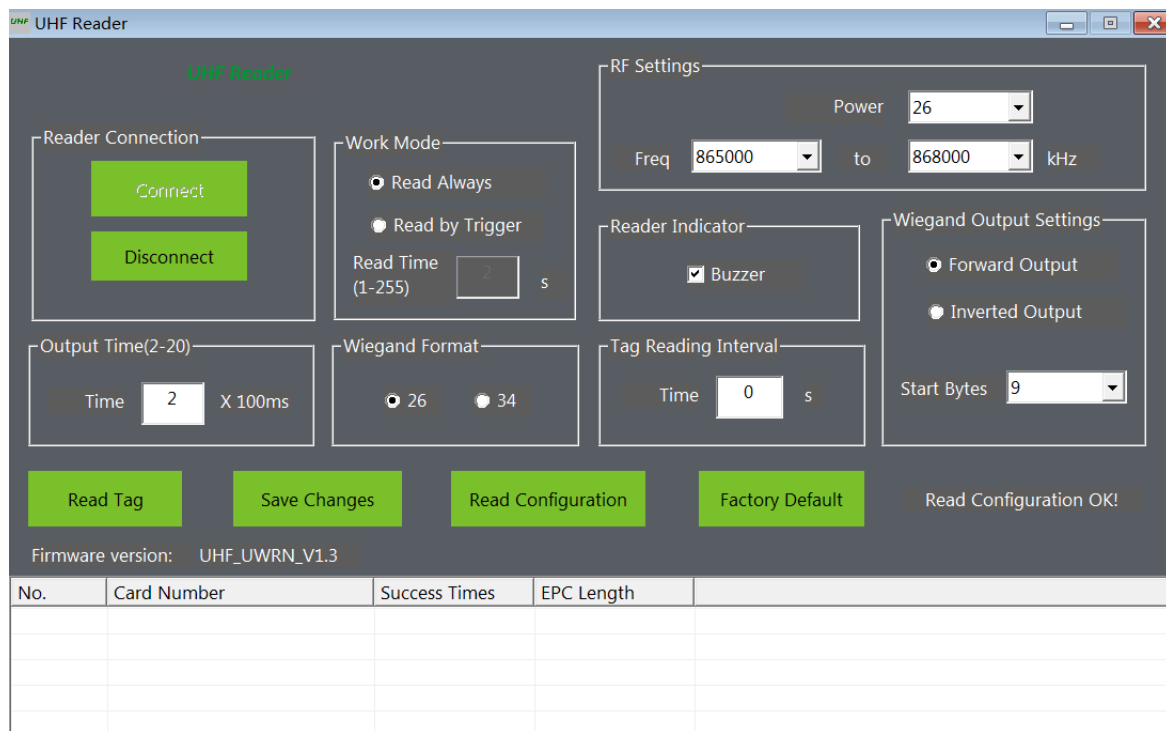

The default configuration of the Standalone Terminal is as follows:

<b>Work Mode</b>	Always Read
<b>Read Tag Interval Time</b>	0s (Default)
<b>Wiegand Out Setting</b>	wiegand 26; Forward Output; 9th Start Byte(Default);
<b>Wiegand Interval Time</b>	2s (Default)
<b>Output Power</b>	18dBm~26dBm
<b>Working Frequency</b>	902MHz ~926MHz 865MHz ~ 868MHz

#### Demo Using Instructions:

- Connect the USB port of the Standalone Terminal to the USB port of the computer.
- The power adapter is recommended to use the DC12V/3A specification. Power supply to the Standalone Terminal and the buzzer sounds once.
- In the computer to open Demo, click 'Connect', on the right side of the middle will show 'Connect Successful', and machine and demo connection success.
- Wiegand Interval Time: Sets the time interval between adjacent wiegand data.
- Reader Indicate: Set whether the buzzer rings when the machine is on the electricity and brush the card.
- Work Mode: Set the working mode of the machine, and including always read mode, trigger mode. Under trigger mode, time of reading card can be set when it is triggered once.
- RF Setting: Set the RF parameters of the machine, including power, spectrum. Power range is

18~26dBm.

- Wiegand Setting: Set the machine's wiegand output format.
- Setting Wiegand Out Bytes: Sets the forward or reverse output of the machine's Wiegand Data, and start output from the first few bytes.
- Read Tag Interval Time: Set the machine to read the card interval. Read card interval is the time when from the card is read within the scope of the card to the card is left out of the scope of the card to read the second time card.

## 6. Access to Software

### RJ45 Connection

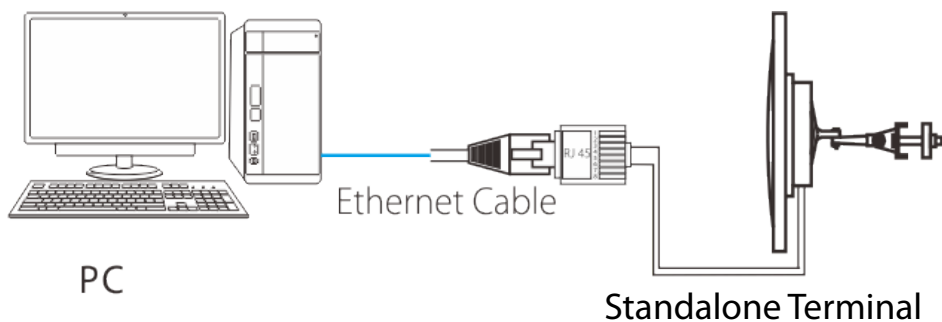

Connect the RJ45 port of the Standalone Terminal to the Ethernet port of the computer. The machine supports access to ZKAccess 3.5.3 build 0009 and ZKBioSecurity 3.0.5.0 software.

### 6.1. Access to ZKAccess

- 1) Add Device:
  - Search the Standalone Terminal

Click [Device] > [Search Panels], click [Start Search] to search the Standalone Terminal by TCP/IP.

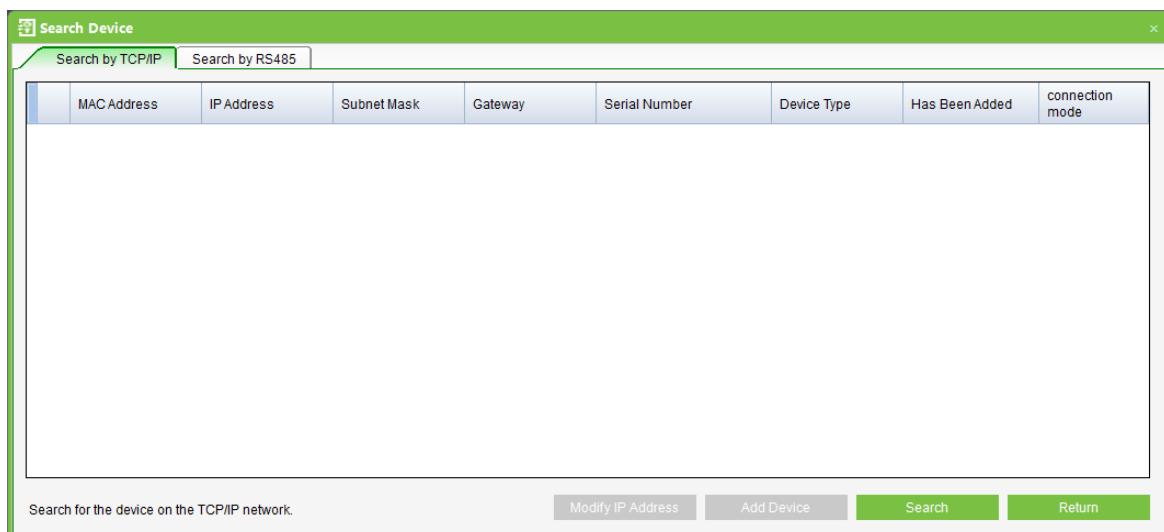

## ➤ Add Device

After searching, select the Standalone Terminal and click [Add Device], and a dialog box will open. Enter self-defined device name, device type set to Standalone Device and click [OK] to complete device adding.

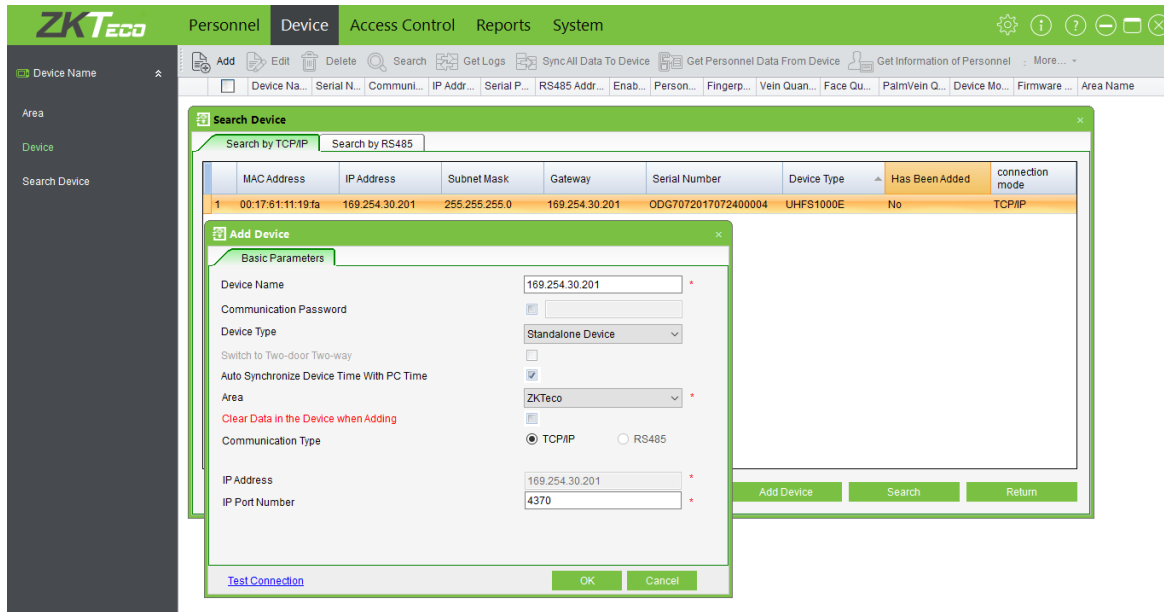

**Note:** The default IP address of the Standalone Terminal may conflict with the IP of a device on the Internet. You can modify its IP address: Click [Modify IP Address] behind the device and a dialog box will open. Enter the new IP address and other parameters (Note: Must configure the gateway and IP address in the same network segment).

## 2) Register the UHF tag

Connect the UHF Card Issuer to a computer; click the **Personnel Profile** tab to register the UHF tag, as shown in the figure below:

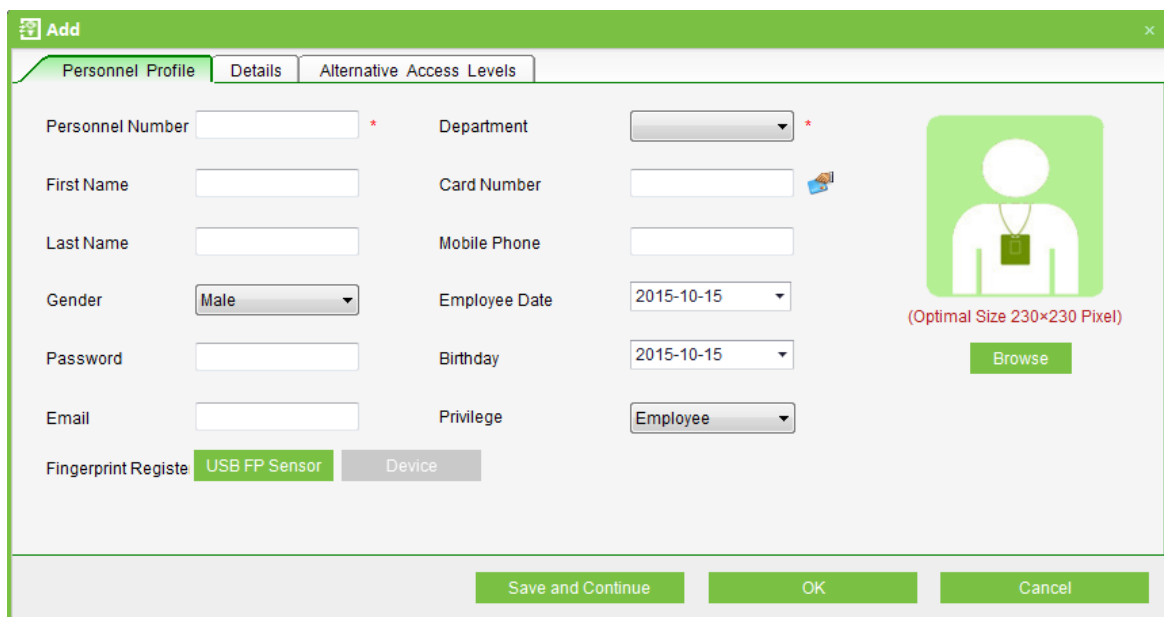

### 3) Set Access Control Parameters

The Access Control Parameters include time zones, holidays, door settings, access levels, anti-passback, personnel group, multi-card opening and so on. For more details about how to set the access control parameters, please see the software user manual.

### 4) Sync All Data to Device

Select device, click [Synchronize All Data] and click [OK] to complete synchronization. The system will synchronize the data to the device, including door information, access control levels (personnel information, access control time zones), anti-pass back settings, interlock settings, linkage settings, first-card normal open settings, multi-card normal open settings and so on.

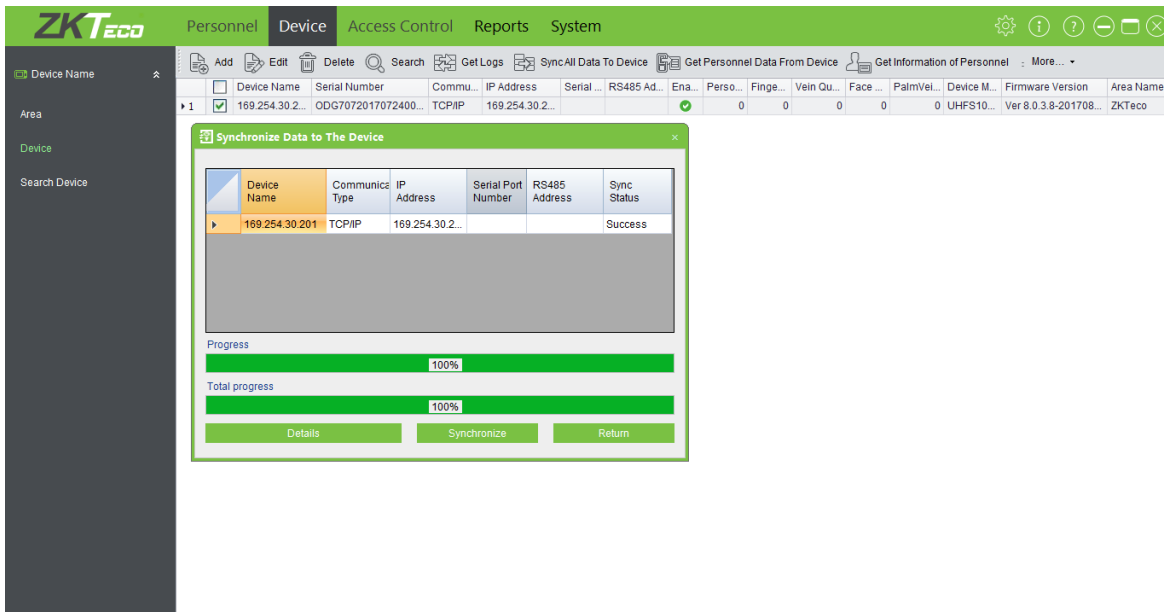

### 5) Real-time Monitoring

Monitor the statuses and real-time events of doors under the access control panels in the system in real-time, including normal events and exceptional events (including alarm events).

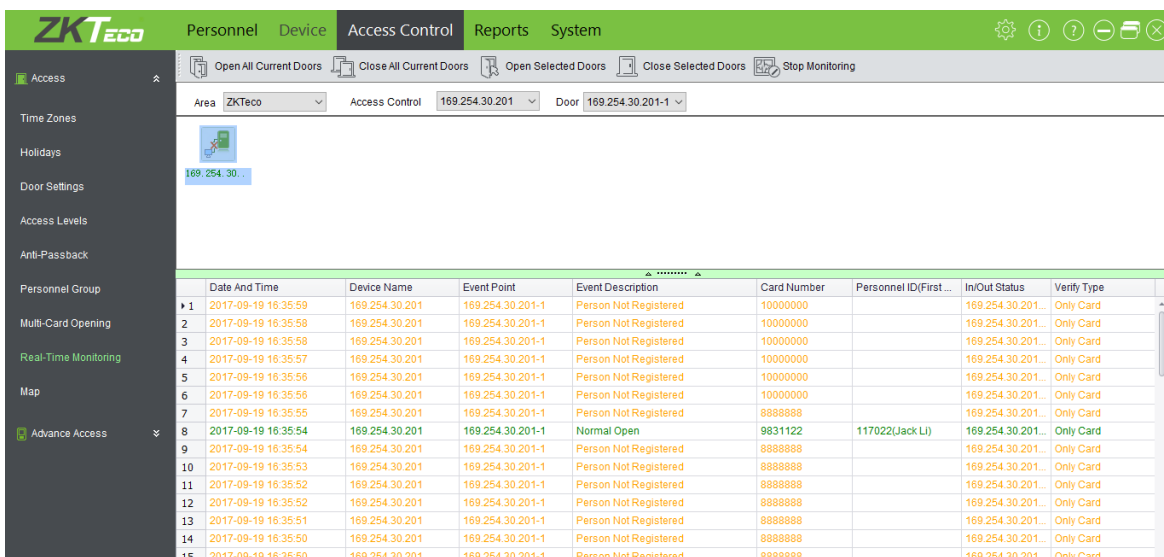

## 6.2. Access to ZKBioSecurity

The procedure to access to ZKBioSecurity is basically the same as [6.1. Access to ZKAccess](#); for more details, please see the software user manual.

## 7. Solution

### 1) Long Distance Access Control Management

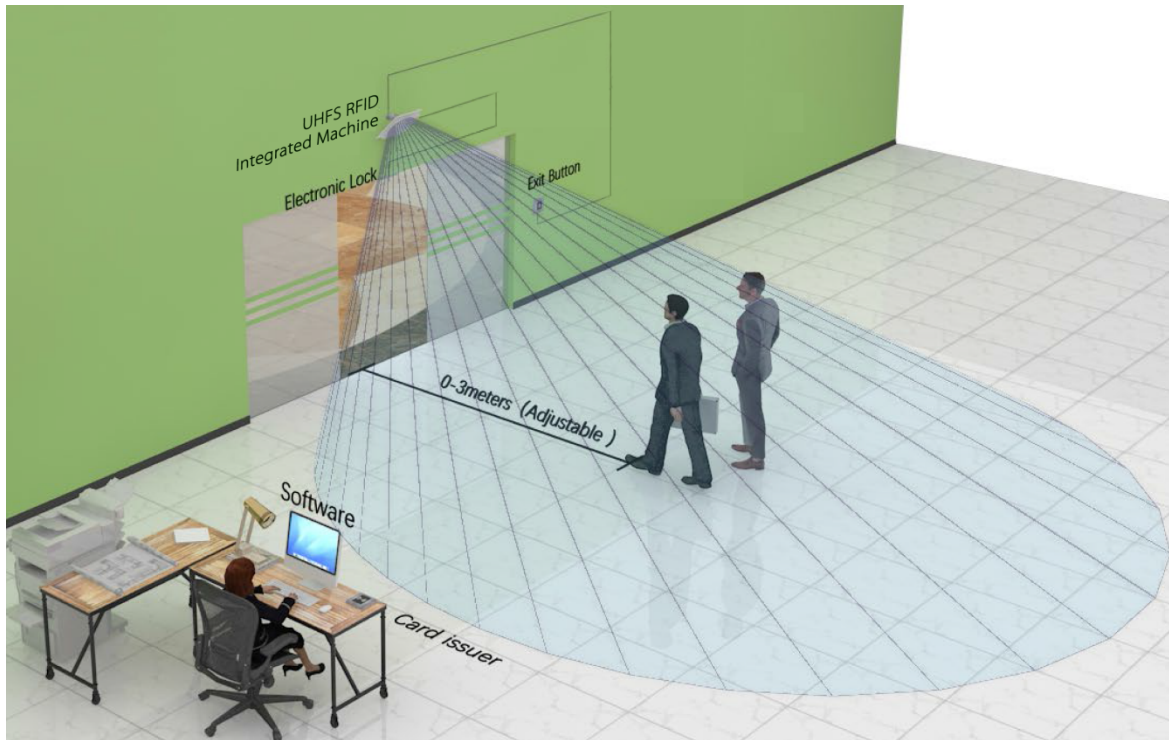

Compared with the traditional access control close proximity recognition mode, long distance access control gets rid of the passive recognition of the shackles, really realize the “Hand Free” model. Remote sensing, automatic reading card, automatic identification, will greatly improve the convenience of personnel access.

The long distance access control system consists of U1000 series Standalone Terminal, UHF tag1, tag2 or DF cards, UR10Rseries card issuer, electronic lock and door.

### 2) The Long Distance Fixed Vehicle Access Management for Parking Lots

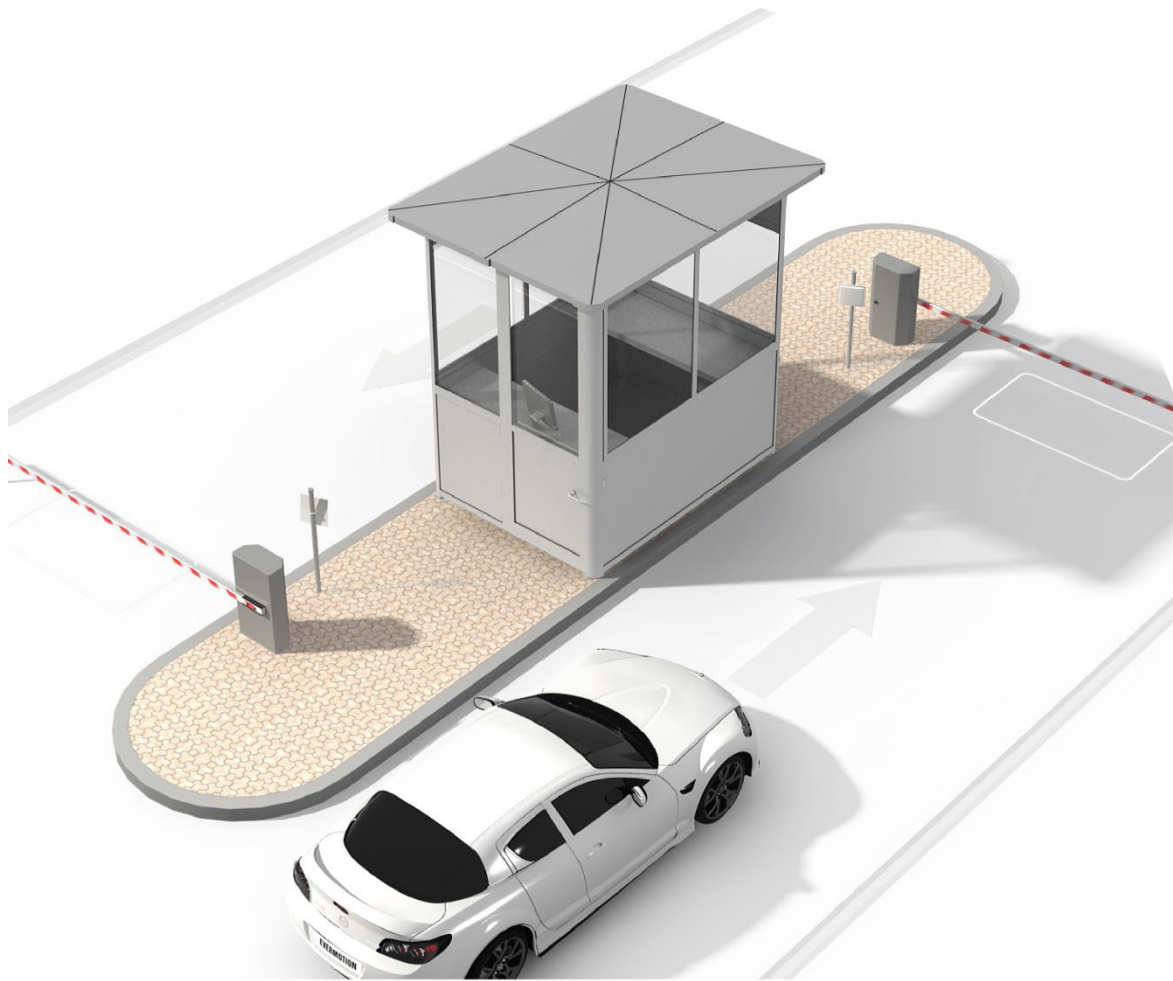

This solution provide user with a non-stop, no card, quick access to parking lots experience. The system consists of U2000 series Standalone Terminal, UHF tag3 (installed on the upper or lower edges of the license plate) or tag4 (pasted on the interior windshield of car), and parking barrier.

When the car pulls up the range of the U2000 Standalone Terminal, the authorized tag mounted on car will be identified, then reading information is transmitted to the Standalone Terminal, after identification correctly, Standalone Terminal outputs an "open" signal to the barrier, then the gate is open. At last, the car can easily have access to parking lots.

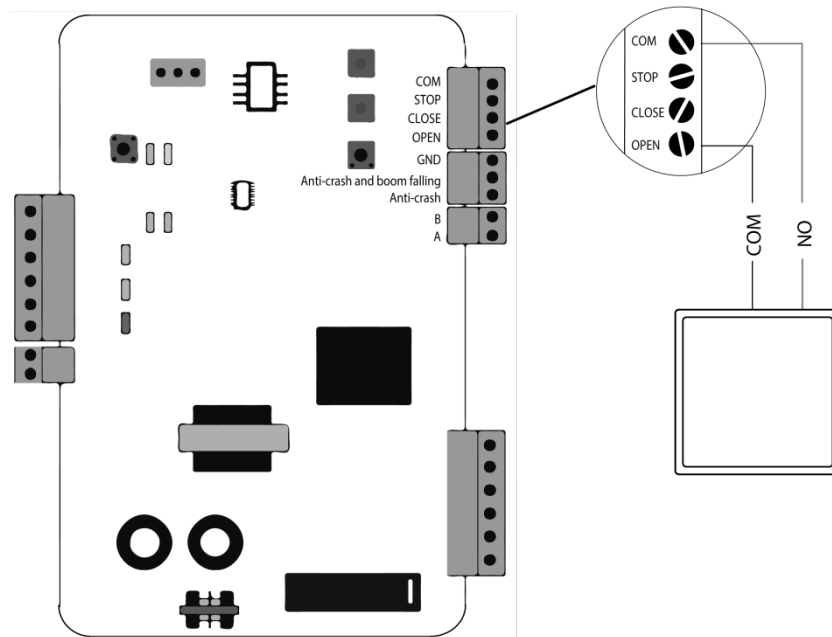

U2000 Standalone Terminal connect with parking barrier

## 8. Note

- The Standalone Terminal cannot be installed in a high-voltage environment, for example, high tension wires and high-voltage transformers.
- The Standalone Terminal cannot be installed near strong magnetic field.
- If the Standalone Terminal is installed at a T-junction or a 90° corner or in other unfavorable environment, the Standalone Terminal may fail to read the card due to the overlarge reading angle. You can install an additional Standalone Terminal at the corner to solve the problem.
- For such terrains as slopes, adjust where the Standalone Terminal faces, turning it downwards within the effective range of card reading.
- Remote card reading by the UHF Standalone Terminal is affected by the protective film (explosion-proof film) on car windows to some extent.
- Remote card reading by the UHF Standalone Terminal is affected on rainy, snowy or windy days to some extent.

ZK Building, Wuhe Road, Gangtou,  
Bantian, Buji Town, Longgang District,  
Shenzhen China 518129

[www.zkteco.com](http://www.zkteco.com)

